

Article number: 51030462000010

Description: Vibration damper GS-M2  
100x60x2000-15, NR shore 57

## Measures

---

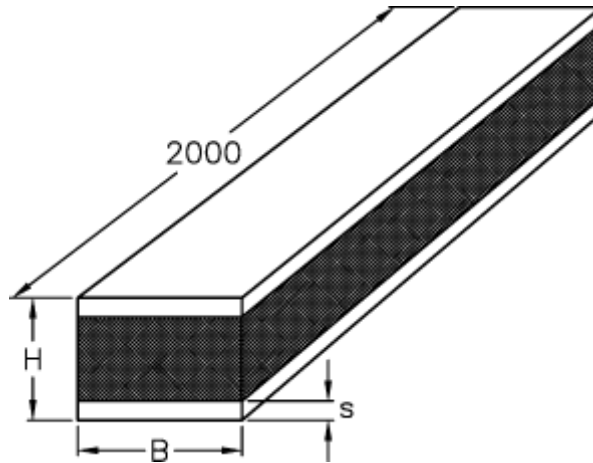

B = 100

H = 60

S = 15